



HYPONTECH CHINA (HEADQUATER)

No.1508 Xiangjiang Road, SUZHOU, CHINA 215000

Enquiry Email: info@hypontech.com

Service Email: service@hypontech.com

Contact: +86 512 8071 2199

HYPONTECH AUSTRALIA

Unit 604/7 Jenkins Rd, CARLINGFORD, NSW 2118

Service Email: service.au@hypontech.com

Service Line: +61 028 054 0377

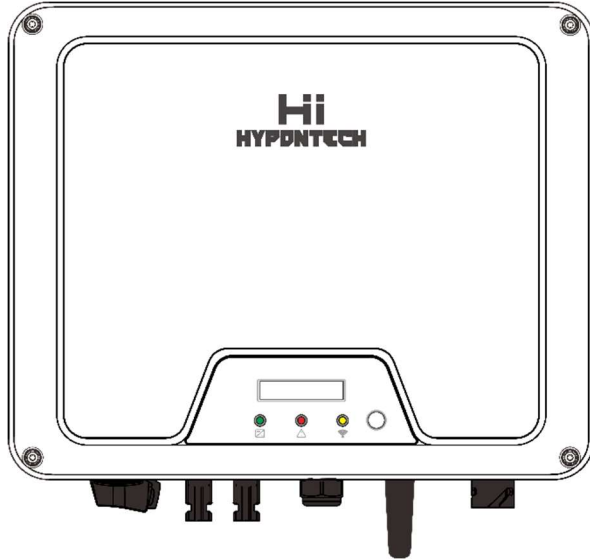

HPT Series













3-Phase Grid-tied Solar Inverters

USER MANUAL

CATALOGUE

1. SYMBOLS ON THE LABEL	4
2. SAFETY AND WARNINGS	4
3. UNPACKING.....	5
3.1 Scope of Delivery.....	5
3.2 Product Overview	6
4. INSTALLING	7
4.1 Installation Requirement	7
4.2 Mounting Location	8
4.3 Mounting.....	9
4.4 Installing the PE cable	9
5. COMMISSIONING.....	10
5.1 Safety Instructions	10
5.2 AC Wire Assembly and Connection	11
5.3 DC Wire Assembly and Connection	12
5.4 Residual Current Protection.....	12
6. COMMUNICATION	13
6.1 System monitoring via Datalogger - RS485/Wi-Fi /GPRS (Optional)	13
6.2 Output Efficiency Control via Smart Meter.....	14
6.3 Demand Responsive Modes (DRMs)	15
7. START UP AND OPERATION.....	17
7.1 Safety Check Before Start Up.....	17
7.2 Inverter LED Indicators	18
7.3 Display and Control Logics	19
8. DISCONNECTING FROM VOLTAGE RESOURCES.....	20
9. TECHNICAL PARAMETERS.....	21
10. TROUBLE SHOOTING	26
11. SYSTEM MAINTENANCE.....	31
12. CERTIFICATES	32

1. SYMBOLS ON THE LABEL

	DANGER, WARNING AND CAUTION		RECYCLABLE AND REUSABLE
	HIGH VOLTAGE AVOID CONTACT		AVOID DAMP AND MOISTURE
	HIGH TEMPERATURE AVOID CONTACT		SHIPMENT STACK LIMIT: 8
	CE MARKS		DO NOT DISPOSE WITH HOUSEHOLD WASTE
	PROCEED OPERATIONS AFTER 5 MINUTES DISCHARGE		BREAKABLE ITEM
	PLACE UPWARDS		USER MANUAL IN PACK

2. SAFETY AND WARNINGS

1. All persons who are responsible for mounting, installation, commissioning, maintenance, tests, and service of HYPONTECH inverter products must be suitably trained and qualified for corresponding operations. They MUST be experienced and have knowledge of operation safety and professional methods. All installation personnel must have knowledge of all applicable safety information, standards, directives, and regulations.
2. The product must ONLY be connected and operated with PV arrays of protection class II, in accordance with IEC 61730, application class A. The PV modules must also







be compatible with this product. Power resources other than compatible PV arrays MUST not be connected and operate with the product.

3. When designing or constructing a PV system, all components MUST remain in their permitted operating ranges, and their installation requirements MUST always be fulfilled.
4. Under exposure to sunlight, the PV array may generate dangerous output in DC voltage. Contacts with the DC wires, conductors and live components in the inverter may result in lethal shocks.
5. High voltages in inverter could cause lethal electrical shocks. Before proceeding any work, including maintenance and/or service, on the inverter, fully disconnect it from all DC input, AC grid and other voltage sources. There MUST be a 5-minute waiting time after the full disconnection.
6. The DC input voltage of the PV array MUST never exceed the maximum input voltage of the inverter.
7. DO NOT touch parts of the inverter during operation as heat will be induced and these parts will exceed 60°C.

3. UNPACKING

3.1 Scope of Delivery

Please inspect and check for completeness in the scope of delivery. Confirm with purchase order.

						
INVERTER	MOUNTING BRACKET	MOUNTING ACCESSORIES	DC PLUGS (SEALED)	AC CONNECTOR	COMMUNICATION DATALOGGER (OPTIONAL)	DOCUMENTS
1	1	1	2	1	1	1

3.2 Product Overview

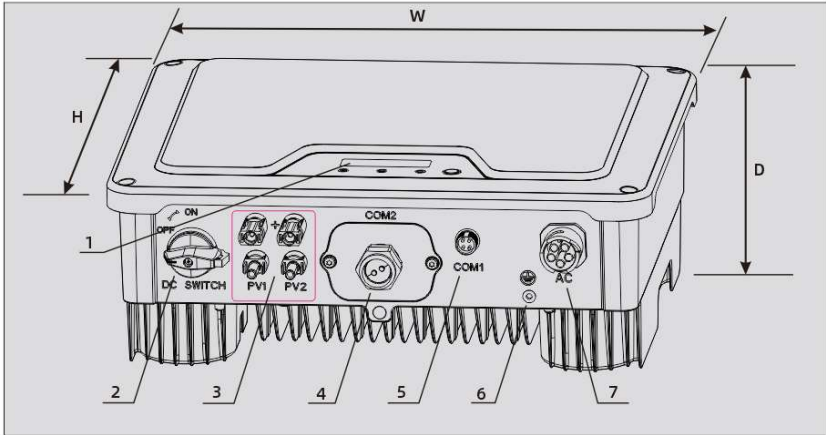

- 1 LED&LCD or LED
- 2 DC Switch
- 3 PV Terminal (s)
- 4 COM1: Wi-Fi/GPRS (Optional)
- 5 COM2: RS485/METER/DRED
- 6 Secondary PE Terminal
- 7 AC Terminal

4. INSTALLING

4.1 Installation Requirement

1. Please install the inverter(s) in places that can avoid inadvertent contact.
2. Installation method, location and surface must be fitting for the inverter's weight and dimensions.
3. Please install the inverter in an accessible location for operation, future maintenance and service.
4. The inverter performance peaks at ambient temperature lower than 45°C.
5. When installing in residential or domestic environment, it is recommended to install and mount the inverter on a solid, concrete wall surface. Mounting the inverter on composite or plaster boards or walls with similar materials would induce noise during its operation and is therefore not recommended.
6. DO NOT cover the inverter NOR place any objects on top of the inverter.
7. To ensure sufficient room for heat dissipation and maintenance, the clearing space between inverter(s) and other surroundings is indicated below for reference:

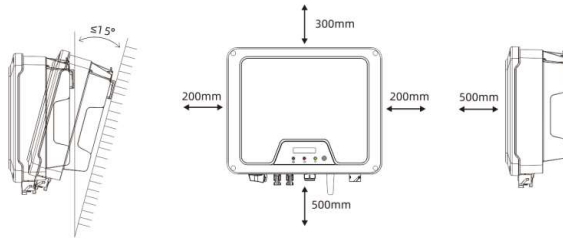

8. Avoid direct exposure to sunlight and rain and snow layup.

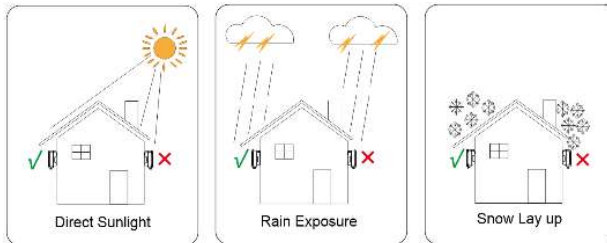

4.2 Mounting Location

1. DO NOT mount the inverter near any inflammable materials.
2. DO NOT mount the inverter near any explosive materials.

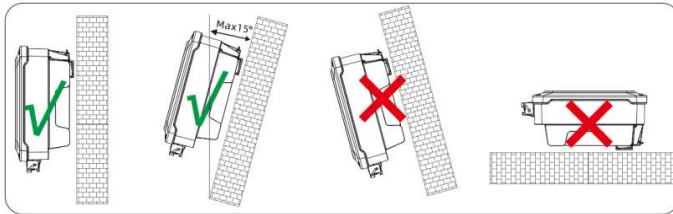

3. DO NOT mount the inverter on tilting surface over 15° backwards. Please mount the inverter on a vertical wall surface.
4. DO NOT mount the inverter on any surfaces tilting forward or to either sides.
5. DO NOT mount the inverter on a horizontal surface.
6. For easy installation and operation, please mount the inverter on a height that the display could match eye level.
7. The bottom side where all commissioning terminals are equipped MUST always point downwards.

4.3 Mounting

1. Use the mounting paper guide as a template and drill holes of 10mm diameter and 70mm depth.
2. Fix the mounting bracket with the screws and expansion bolts packed in mounting accessories.
3. Hold up the inverter and tilt it slightly forward. Hang up the inverter and attach it to the mounting bracket. Check both sides of the heat sink to ensure its stably attached.
4. Use M5 screws (T25 screwdriver, torque 2.5 Nm) to attach the heat sink fins to the mounting bracket.
5. It is recommended to attach the anti-theft lock to the inverter. Lock diameter $\varnothing 4-5.5\text{mm}$ recommended.

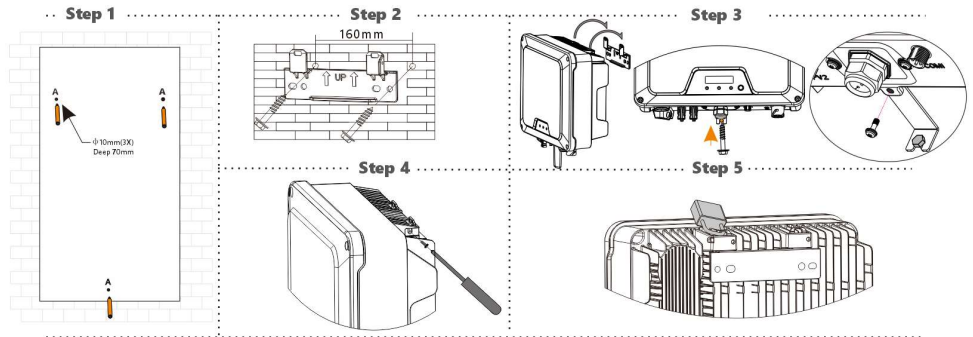

4.4 Installing the PE cable

1. Insert the grounding conductor into the suitable terminal lug and crimp the contact.
2. Align the terminal lug with the grounding conductor and the ground washer on the screw. The teeth of the ground washer must be facing the housing.
3. Tighten it firmly into the housing (screwdriver type: T25, torque: 2.5Nm).

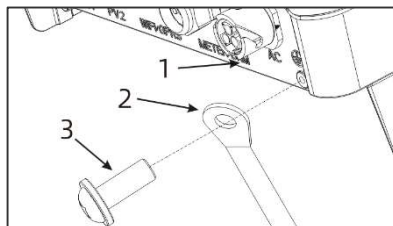

Information on grounding components:

Object	Description
1	Housing
2	M5 terminal lug with protective conductor
3	M5×12 pan head screw

5. COMMISSIONING

5.1 Safety Instructions

1. Measure the frequency and voltage of grid connection and make sure they follow the inverter's grid connection specifications.
2. An external circuit-breaker on the AC side (or a fuse) at 1.25*AC rated current is strongly recommended.
3. Reliability of all earth connections must be tested and valid.
4. Before commissioning, disconnect the inverter and the circuit-breaker or fuse, and prevent accidental reconnection.

5.2 AC Wire Assembly and Connection

5.2.1 AC Commissioning

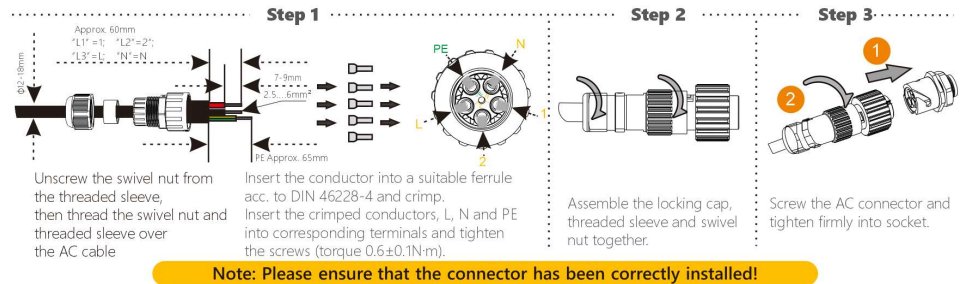

5.2.2 AC Switch Types

Please install an individual 2-stage miniature circuit breaker according to the following specifications.

Model	Maximum output current (A)	AC Breaker Rated current (A)
HPT-3000	5	16
HPT-4000	6.5	16
HPT-5000	8.5	16
HPT-6000	9	16
HPT-8000	13	25
HPT-10000	15.2	25
HPT-11000	16	25

5.3 DC Wire Assembly and Connection

1. PV modules of the connected strings must be of: the same time, identical alignment and tilting angle.
2. Before commissioning and connecting the PV arrays, the DC switch MUST be open.
3. Parallel strings must have the same number of modules.
4. It is mandatory to use the DC connectors within package for the connection of PV arrays.
5. The polarity of the PV arrays MUST be compatible to the DC connectors of the inverter.
6. The DC input voltage AND DC input current of the PV array MUST never exceed the maximum input allowance of the inverter.

DC Commissioning:

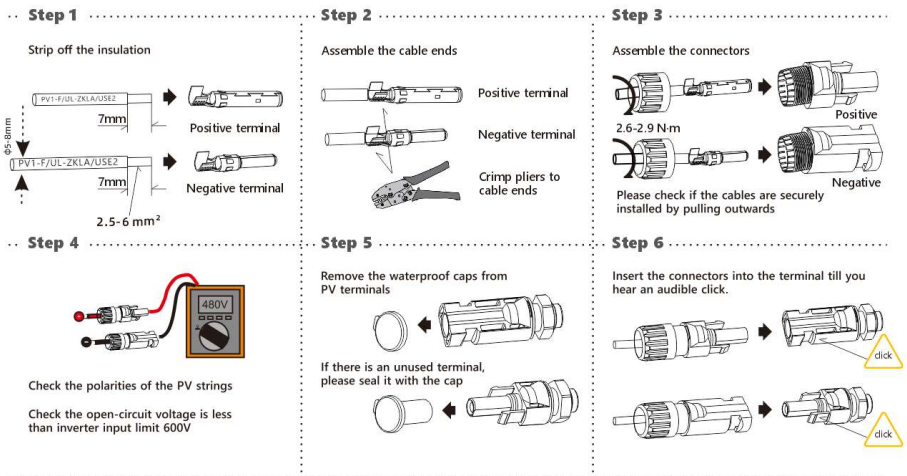

5.4 Residual Current Protection

This product is equipped with residual current protection device internally, in accordance with IEC 60364-7-714. An external residual current protection device is not needed. If the local regulation demands otherwise, it is recommended to install a 30mA Type B residual current protection device.

6. COMMUNICATION

6.1 System monitoring via Datalogger - RS485/Wi-Fi /GPRS (Optional)

6.1.1 Wi-Fi /GPRS Datalogger Installation

1. Unpack the Datalogger from package.
2. Unscrew the cap in COM1 port and plug the Datalogger in and tighten.
3. For user guidance and configuration of Datalogger, please refer to the corresponding HYPONTECH Wi-Fi Stick Guide manual, which is available in printed form inside Documents pack, or an online manual on HYPONTECH website at <https://www.hypontech.com/xiazai>.

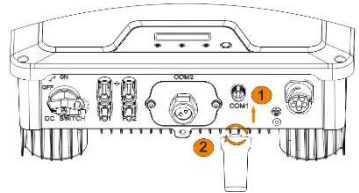

6.1.2 RS485 Installation

If the communication module is connected via RS485:

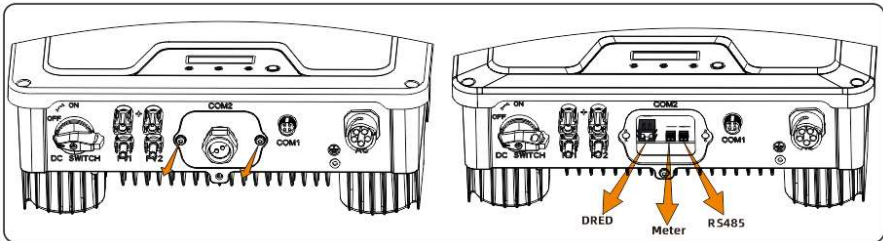

Step 1: Unscrew with T25 screwdriver and remove the COM sealing plate. The terminals of DRED/Meter/RS485 is exposed as indicated.

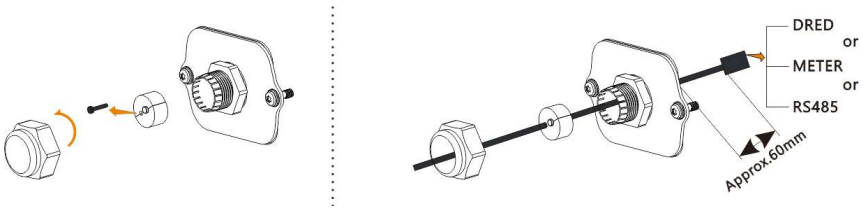

Step 2: Unscrew the nut of cable gland and take out the rubber cylinders. Please seal the cable gland properly if there is an unused hole to prevent moisture and dust.

Step 3: Connect the crimped cables to RS485 / Meter terminals and secure by (blade 0.4x2.5) screwdriver.

RS485/METER connection

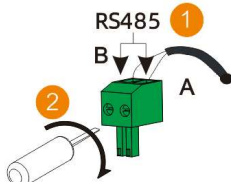

screwdriver type: Blade 0.4 x 2.5

DRED connection

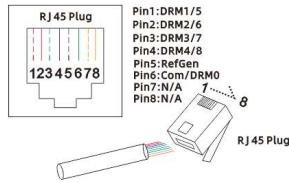

Pin1:DRM1/5
Pin2:DRM2/6
Pin3:DRM3/7
Pin4:DRM4/8
Pin5:RefGen
Pin6:Com/DRMO
Pin7:N/A
Pin8:N/A

Connect the crimped cables to RS485 / Meter terminals/DRED and secure by (blade 0.4x2.5) screwdriver

Step 4: Tighten the nut to prevent the cable from wobbling.

Step 5: Put on the COM sealing plate and firmly tighten the screws to prevent moisture and dust. (Screwdriver type: T25; Torque: 2.5 Nm)



When installing RS485, the COM sealing plate needs to be removed. All operation MUST NOT proceed until AC and DC power is securely disconnected and discharged to prevent electric shocks.

6.2 Output Efficiency Control via Smart Meter

The inverter's active power output and efficiency could be monitored via the application of a smart meter.

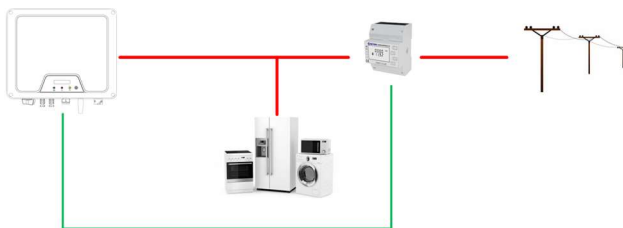

Please refer to **EASTRON SDM630-Modbus V2 User manual** for its connection and baud rate settings.

6.3 Demand Responsive Modes (DRMs)



DRMs Application Description

- Only applicable to AS/NZS4777.2:2015.
- DRM0, DRM5, DRM6, DRM7, DRM8 are available.

The inverter shall detect and initiate a response to all supported demand response commands.

MODE	DEMAND
DRM 0	Disconnect
DRM 1	No power consumption
DRM 2	Power consumption <50% rated power
DRM 3	Power consumption <75% rated power AND respond to reactive power when capable
DRM 4	Increase power consumption (prior subject to constraints from other active DRMs)
DRM 5	No power generation
DRM 6	Power generation <50% rated power
DRM 7	Power generation <75% rated power AND sink reactive power if possible
DRM 8	Increase power generation (prior subject to constraints from other active DRMs)

Moistures and Dust will damage the inverter

- Secure and tighten the screws on COM sealing plate.
- Warranty will be void if the inverter is damaged due to moisture and dust caused by poor installation of COM sealing plate.

7. START UP AND OPERATION

7.1 Safety Check Before Start Up



Please check before switching on any voltage resources connected to the inverter and closing inverter's DC switch:

1. Grid Voltage: Check the grid voltage at point of connection at the inverter complies with permitted range of the inverter.
2. Mounting Bracket: Check if the mounting bracket is properly and securely installed.
3. Mounting of the inverter: Check if the inverter is properly mounted and attached to the mounting bracket.
4. DC Connectors: Check if the DC connectors are installed correctly on terminals.
5. AC Connectors and Wire Assembly: Check if wires are assembled correctly on the AC side and if the AC connector is properly and securely installed. Check if the AC connector is firmly plugged into AC terminal.
6. Cables: Check if all cables are reliably connected. Check if the connections are effective, while the insulations are undamaged.
7. Groundings: Check all groundings using multimeter and if all exposed metal parts of the inverter are properly grounded.
8. DC Voltage: Check if the largest open-circuit voltage of PV arrays complies with the permitted range.
9. DC Polarity: Check if the wires from DC voltage resource are connected to terminals with correct polarity.
10. Grounding Resistance: Check if the grounding resistance of PV strings $>1\text{M}\Omega$ using a multimeter.

After all installation and checks, close the AC circuit-breaker, then the DC switch. The inverter will start to operate when DC input voltage and grid conditions meet the requirements of inverter startup.

7.2 Inverter LED Indicators

When the inverter operates, LED symbols on display have the following meanings:

 POWER	<ul style="list-style-type: none"><input checked="" type="radio"/> ON Inverter Power ON and Feeding Power to Grid<input type="radio"/> Blink Inverter Power ON. Not Feeding Power to Grid<input type="radio"/> OFF Inverter Power OFF. DC Disconnected
 FAULT	<ul style="list-style-type: none"><input checked="" type="radio"/> ON Inverter is Faulty<input type="radio"/> OFF No Fault
 COM	<ul style="list-style-type: none"><input type="radio"/> Blink Communication Device Connected<input type="radio"/> OFF Communication Device Disconnected

7.3 Display and Control Logics

When inverter starts up and operates, there is a control button beside LCD Display of the inverter. Please follow the logics listed below.

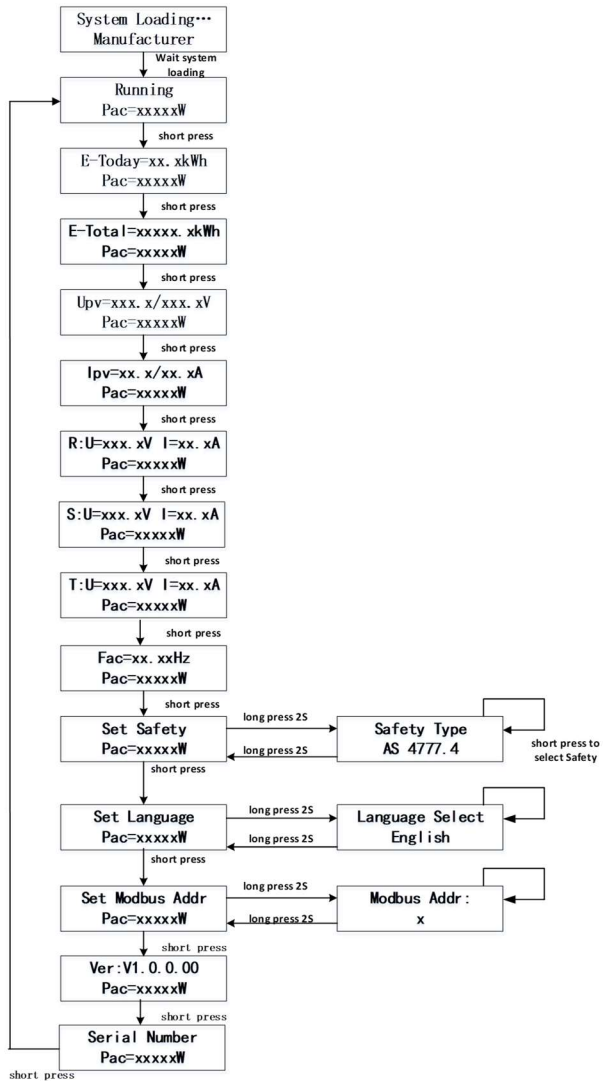

8. DISCONNECTING FROM VOLTAGE RESOURCES

Before proceeding any operations on inverter, please disconnect the inverter from all voltage resources as described in this manual.

Following these steps in described sequence are mandatory.

1. Disconnect miniature circuit-breaker and prevent from unintentional reconnections.
2. Open the DC switch and prevent the switch from closing unintentionally.
3. Use clamps to ensure there is no electrical current in DC wires.
4. Disconnect all DC connections and resources. Unplug the DC connectors, and DO NOT pull the cables.



5. Use multimeter to ensure the voltage on DC terminals of inverter is 0.
6. Unscrew and remove the AC connector.

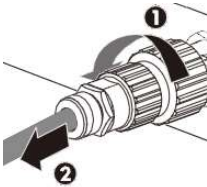

Danger to life due to high voltages.

Inverter capacitors need 10 minutes to be completely de-energized. Please wait for 10 minutes to remove the cover.

When an error occurs, DO NOT remove the cover of the inverter onsite. Improper operations and attempts may induce electric shock.

9. TECHNICAL PARAMETERS

Module	HPT-3000	HPT-4000	HPT-5000	HPT-6000
INPUT/DC				
Max. PV Power (Wp)	4620	6160	7700	8400
Max. Input Voltage (V)	1000			
MPP Voltage Range (V)	180~850			
Min. DC Voltage (V)	150			
Nominal DC-Input Voltage (V)	620			
Max. Input Current (A)	12.5/12.5			
Max. short DC current (A)	15.6/15.6			
No. of independent MPPT inputs	2			
No. of PV strings per MPPT	1			
Max. inverter backfeed current to the array (A)	0			
OUTPUT/AC				
Rated Power (W)	3000	4000	5000	6000
Max. apparent AC power (VA)	3300	4400	5500	6000
Rated grid voltage (Vac)	380/400			
Rated power frequency (HZ)	50/60			
Max. output current (A)	5	6.5	8.5	9
Max. output overcurrent protection(A)	16	16	16	16
Inrush current (Peak and duration)*	7.6A @1.24ms	7.6A @1.24ms	7.6A @1.24ms	7.6A @1.24ms
Max. output fault current(Peak and duration)*	39.6A @320us	39.6A @320us	39.6A @320us	39.6A @320us
Adjustable displacement power factor	0.8ind to 0.8cap			

THDi at rated power	<3%			
EFFICIENCY				
Max. Efficiency	98.0%	98.0%	98.1%	98.1%
Euro Efficiency	97.4%	97.4%	97.4%	97.4%
MPPT Efficiency	99.9%			
PROTECTION				
Anti-islanding Protection	Integrated			
Input Reverse Polarity Protection	Integrated			
Insulation Resistor Detection	Integrated			
Residual Current Monitoring Unit	Integrated			
Output Over Current Protection	Integrated			
Output Short Protection	Integrated			
Output Over Voltage Protection	Integrated			
GENERAL DATA				
Dimensions(W*H*D) mm	425*346*160			
Weight (kg)	13.7			
Noise emission(typical) dB(A)	<20			
User Interface	LED&LCD or LED			
DC connection type	MC4 (SUNCLIX, H4 optional)			
AC connection type	Plug-in Connector			
Communication	RS485/WiFi/GPRS(optional)			
Cooling method	Natural cooling			
Operating ambient temperature range	-25°C....+60°C			
Allowable relative humidity range	0%~100%			
Max. operating altitude(m)	3000(>2000 derating)			
Degree of protection(IEC 60529)	IP65			
Climatic category (IEC 60721-3-4)	4K4H			
Isolation method	Transformerless			
Power loss in night mode	<1W			

Model	HPT-8000	HPT-10000	HPT-11000
INPUT/DC			
Max. PV Power (Wp)	11500	13000	13000
Max. Input Voltage (V)	1000		
MPP Voltage Range (V)	180~850		
Min. DC Voltage (V)	150		
Nominal DC-Input Voltage (V)	620		
Max. Input Current (A)	12.5/12.5		
Max. short DC current (A)	15.6/15.6		
No. of independent MPPT inputs	2		
No. of PV strings per MPPT	1		
Max. inverter backfeed current to the array (A)	0		
OUTPUT/AC			
Rated Power (W)	8000	10000	10500
Max. apparent AC power (VA)	8800	10000	10500
Rated grid voltage (Vac)	380/400		
Rated power frequency (HZ)	50/60		
Max. output current (A)	13	15.2	16
Max. output overcurrent protection(A)	25	25	25
Inrush current (Peak and duration)*	7.6A @1.24ms	7.6A @1.24ms	7.6A @1.24ms
Max. output fault current(Peak and duration)*	39.6A @320us	39.6A @320us	39.6A @320us
Adjustable displacement power factor	0.8ind to 0.8cap		
THDi at rated power	<3%		
EFFICIENCY			
Max. Efficiency	98.2%	98.2%	98.2%
Euro Efficiency	97.5%	97.5%	97.5%
MPPT Efficiency	99.9%		

PROTECTION	
Anti-islanding Protection	Integrated
Input Reverse Polarity Protection	Integrated
Insulation Resistor Detection	Integrated
Residual Current Monitoring Unit	Integrated
Output Over Current Protection	Integrated
Output Short Protection	Integrated
Output Over Voltage Protection	Integrated
GENERAL DATA	
Dimensions(W*H*D) mm	425*346*160
Weight (kg)	14
Noise emission(typical) dB(A)	<25
User Interface	LCD&LED or LED
DC connection type	MC4 (SUNCLIX, H4 optional)
AC connection type	Plug-in Connector
Communication	RS485/WiFi/GPRS(optional)
Cooling method	Natural cooling
Operating ambient temperature range	-25°C....+60°C
Allowable relative humidity range	0%~100%
Max. operating altitude(m)	3000(>2000 derating)
Degree of protection(IEC 60529)	IP65
Climatic category (IEC 60721-3-4)	4K4H
Isolation method	Transformerless
Power loss in night mode	<1
<p>Note</p> <p>"*" The inrush current and Max. output fault current are really test values.</p>	

Inverter power quality response modes	
Power quality response modes	Default operation per AS/NZS 4777.2:2015
Volt-watt response mode	Default: Enabled
Volt-var response mode	Default: Disabled
Fixed power factor mode	Default: Disabled
Reactive power mode	Default: Disabled
Characteristic power factor curve for $\cos \phi$ (P)	Default: Disabled
<p>Note</p> <p>The power quality modes can be enabled or disabled via our monitoring APP or Web. Please refer to the "Safety Parameter Setting User Manual" on our website at https://www.hypontech.com/xiazai, or contact our servicer for more information.</p> <p>Please access the monitoring platform on www.hyponportal.com/signin</p>	

10. TROUBLE SHOOTING

Earth Fault Alarm

This inverter complies with IEC 62109-2 clause 13.9 for earth fault alarm monitoring.

If an **Earth Fault Alarm** occurs, the **error code 6** will be displayed on the LCD. Red LED indicator will also light up.

If an external indication of earth fault alarm is required, please connect PV System to inverter monitoring app/portal. The monitoring platform will send email notification in the event of an Earth Fault. Please refer to Sector 6.1 and HYPONTECH WI-FI STICK GUIDE on how to setup your inverter communication function.

Full Error Code and Corrective Measures

When the PV system does not operate normally, we recommend the following solutions for quick troubleshooting. If an error occurs, the Error code will be displayed on the inverter's screen or on the Hypontech's monitoring App/Web, the red LED will light up.

The corresponding corrective measures are as follows:

Error Code	Fault Name	Description	Corrective Measures
1	Functional fault in Micro-Controller Unit (MCU)	MCU abnormal self-check in start process	Disconnect the inverter from the utility grid and the PV array, and reconnect it after LED turns off. If this fault is still being displayed, please contact service.
2	A faulty current sensor detected	AC current sensor detect current abnormal in the start process	Disconnect the inverter from the utility grid and the PV array, and reconnect it after LED turns off. If this fault is still being displayed, please contact service.
3	Ground fault circuit interrupter (GFCI) sensor error	GFCI sensor self-check abnormal	Disconnect the inverter from the utility grid and the PV array, and reconnect it after LED turns off. If this fault is still being displayed, please contact service.

4	A faulty grid relay detected	The difference between INV voltage and output voltage exceeds limit.	<ol style="list-style-type: none"> 1. Disconnect the inverter from the utility grid and the PV array, and reconnect it after LED turns off. 2. If the fault persists, measure the phase to phase voltage and phase to zero and zero to ground voltage with a multimeter to ensure that the voltage is normal and the zero to ground voltage value should not be greater than 10V. 3. Disconnect the inverter from the utility grid and the PV array, and reconnect it after LED turns off. <p>If this fault is still being displayed, please contact service.</p>
5	PV voltage too high	When the PV voltage of any circuit is greater than 1020V, it is determined as the PV voltage is too high.	Check the open-circuit voltages of the strings and make sure it is below the maximum DC input voltage of the inverter. If the input voltage lies within the permissible range while the fault occurs, please contact the service.
6	Surface insulation resistance error	In the process of power on and start-up, the insulation impedance of PV + and PV - to ground is detected. When the detection insulation impedance is less than 200kohm, it is judged as insulation fault.	<ol style="list-style-type: none"> 1. If it happens occasionally, it may be caused by rainy or humid environment. After the fault is eliminated, the inverter can resume normal operation without other actions. 2. If there is continuous alarm, please check the PV array's insulation to ground and make sure that the insulation resistance to ground is greater than 200KΩ. Otherwise, visual inspection of all PV cables and modules. Make sure the grounding connection of the inverter is reliable. <p>If all above are normal, please contact the service.</p>
7	Ground fault circuit interrupter (GFCI) exceeds the permissible range	residual current over the permission range	<ol style="list-style-type: none"> 1. Make sure the grounding connection of the inverter is reliable. 2. Make a visual inspection of all PV cables and modules. <p>If this fault is still shown, contact the service.</p>

8	Inverter temperature too high	Heat sink and internal environment temperature higher than 85 degree	<p>Please confirm:</p> <ol style="list-style-type: none"> Whether the airflow to the heat sink is obstructed. Whether the installation site is in direct sunlight and ambient temperature around the inverter is too high. <p>If all above is normal, contact the service.</p>
9	Utility grid disconnected	inverter detected grid voltage failed	<ol style="list-style-type: none"> If it happens occasionally, it belongs to the short-time abnormality of the power grid, the inverter will return to normal operation after detecting that the power grid is normal, and there is no need to deal with it. If it cannot be recovered for a long time, please confirm: <ol style="list-style-type: none"> whether the AC circuit breaker is disconnected whether the AC terminal or fuse is in good contact whether the power supply line is normal <p>If this fault is still being shown, contact the service.</p>
10	Grid voltage exceeds the permissible range	grid voltage exceeds the Safety regulations	<ol style="list-style-type: none"> If it happens occasionally, it belongs to the short-time abnormality of the power grid, the inverter will return to normal operation after detecting the normal power grid, and there is no need to deal with it. In case of frequent occurrence but automatic recovery, please confirm if the grid voltage is outside the permissible range due to local grid conditions, try to modify the values of the monitored operational limits after informing the electric utility company first. If it cannot be recovered for a long time, please confirm: <ol style="list-style-type: none"> whether the AC circuit breaker is disconnected whether the AC terminal is in good connection whether the power supply line is normal whether the AC cable wiring (such as wire length and wire diameter) complies with the user manual guidance whether the safety regulation settings are normal

11	Grid frequency exceeds the permissible range	grid frequency exceeds the Safety regulations	<p>1.If it happens occasionally, it belongs to the short-time abnormality of the power grid, the inverter will return to normal operation after detecting the normal power grid, and there is no need to deal with it.</p> <p>2. In case of frequent occurrence but automatic recovery, please confirm if the grid voltage is outside the permissible range due to local grid conditions, try to modify the values of the monitored operational limits after informing the electric utility company first.</p> <p>3.If it cannot be recovered for a long time, please confirm:</p> <p>①whether the AC circuit breaker is disconnected</p> <p>②whether the AC terminal is in good connection</p> <p>③whether the power supply line is normal</p> <p>④ whether the safety regulation settings are normal</p>
12	DC component of the electricity exceeds the permissible range	the current exceeds 1A in static state and 4A in dynamic state	Disconnect the inverter from the utility grid and the PV array, and reconnect it after LED turns off. If this fault is still being displayed, please contact the service.
13	EEPROM Error, e.g. transition disturbance	Micro CPU read EEPROM failed	Disconnect the inverter from the utility grid and the PV array, and reconnect it after LED turns off. If this fault is still being displayed, please contact the service.
14	Internal communication fault	Master CPU communicate with slave CPU abnormal	Disconnect the inverter from the utility grid and the PV array, and reconnect it after LED turns off. If this fault is still being displayed, please contact the service.
15	Bus-voltage too high	Bus-voltage is greater than 1030V	<p>Check the open-circuit voltages of the strings and make sure it is below the maximum DC input voltage of the inverter.</p> <p>If the input voltage lies within the permissible range while the fault occurs, please contact the service.</p>

16	Bus-voltage too low	Bus-voltage is 20V lower than standard Bus-voltage	Check the open-circuit voltages of the strings and make sure it is below the maximum DC input voltage of the inverter. If the input voltage lies within the permissible range while the fault occurs, please contact the service.
17	DRM S9 Error	DRM switch S9 fault	Check the connection of DRM device. If the DRM device is connected normally while this fault occurs, please contact the service.
18	DRM S0 Error	DRM switch S0 fault	Check the connection of DRM device. If the DRM device is connected normally while this fault occurs, please contact the service.
19	N and PE voltage exceeds permitted range		Check if the inverter is securely grounded.

11. SYSTEM MAINTENANCE

For the inverter's long-term performance, it is suggested to maintain your inverter regularly:

NOTICE:

HEAT SINK MIGHT INDUCE INJURY

When the inverter is operating, the heat sink might exceed 60°C

- Please disconnect all electrical cables and connections. Wait for the inverter to cool down completely.
- Use compressed air cleaning or a soft brush to clean the inverter heat sink.
- ALL aggressive chemicals, cleaning solvents or strong detergents are FORBIDDEN

Content	Maintenance Measures	Cycle
System Cleaning	<ul style="list-style-type: none"> • Check if the heat sink is covered and dusted • Maintenance of DC Switch can be performed at night. Turn the switch to ON and OFF positions for 4~5 times. • Use a wet cloth to clean the display 	Annually OR Half a year
System Status	<ul style="list-style-type: none"> • Inspect the enclosure for damage/deformation • Listen for abnormal noises during operation • Check if the parameters are normal during operation 	Half a year
Commissioning	<ul style="list-style-type: none"> • Check if the cables are loose • Check if the cable insulations are damaged, especially the parts in contact with metal surfaces 	Half a year after first commissioning Annually OR Half a year
Grounding	<ul style="list-style-type: none"> • Check if the cables are securely grounded 	Half a year after first commissioning Annually OR Half a year

12. RESTARTS

When reconnecting the inverter for electrical power supply, please follow the commissioning procedures and safety instructions as described in **Section 6** when applicable (e.g. DC Wires need to be reassembled).

Please run safety checks as described in **Section 7** before closing the DC Switch and starting up again,

13. CERTIFICATES

Grid Standards	EN50549-1, AS/NZS4777.2, G98, G99, NBR16149, NB/T32004, IEC61727
Safety Standards	IEC/EN62109-1/-2, NB/T32004
Electromagnetic Compatibility (EMC)	EN61000-6-1, EN61000-6-2, EN61000-6-3, EN61000-6-4, NB/T 32004

